

INFRARED MOTION SENSOR
 INFRAROT-BEWEGUNGSMELDER
 ДАТЧИК ДВИЖЕНИЯ
 ČIDLO INFRAČERVENÉ (PIR) NÁSTĚNNÉ



SES09 - regulacja czujnika



SES10 - regulacja czujnika



SES12 / SES12-A - regulacja czujnika

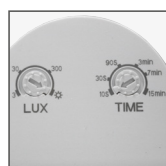

SES15 - regulacja czujnika

SES09BL



SES15BL



SES10WH









SES12WH



SES12BL-A



						
kod	kod EAN	opakowanie	kolor	typ czujnika	zakres detekcji**	moc max [W]
B50-SES09BL	5908311361276	1/50	czarny	PIR	180°x 90°; max 12m	1200/300
B50-SES09WH	5908311361269	1/50	biały	PIR	180°x 90°; max 12m	1200/300
B50-SES10BL	5908311361283	1/50	czarny	PIR	180°x 90°; max 12m	1200/300
B50-SES10WH	5908311361290	1/50	biały	PIR	180°x 90°; max 12m	1200/300
B50-SES12BL	5900280904157	1/50	czarny	PIR	180°x 90°; max 12m	1200/300
B50-SES12WH	5900280904164	1/50	biały	PIR	180°x 90°; max 12m	1200/300
B50-SES12BL-A	5900280914347	1/50	czarny	PIR	180°x 120°; max 12m	800/400
B50-SES12WH-A	5900280914323	1/50	biały	PIR	180°x 120°; max 12m	800/400
B50-SES15BL	5900280908650	1/50	czarny	PIR	180°x 120°; max 12m	1200/300
B50-SES15WH	5900280908667	1/50	biały	PIR	180°x 120°; max 12m	1200/300

**max. zasięg frontalny

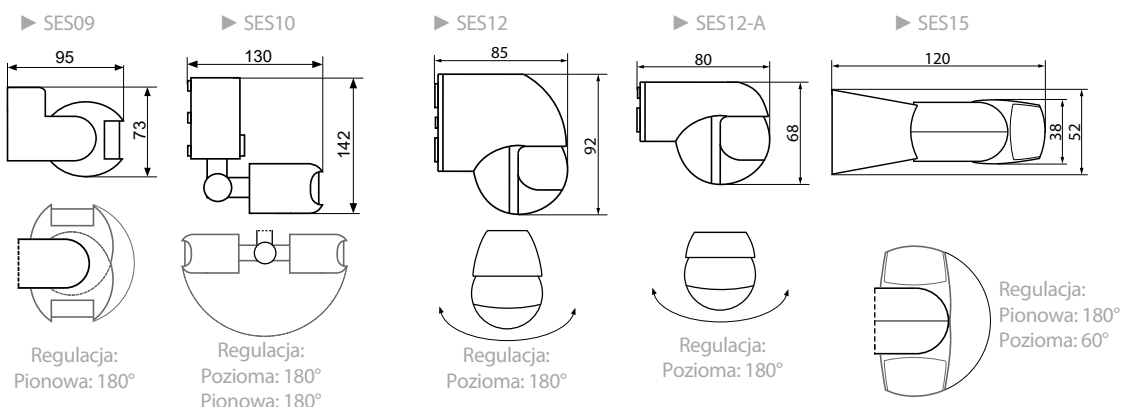

Zeskanuj kod QR
aby uzyskać więcej
informacji o tym produkcie

