

LED TUBE
LED-TUBE
СВЕТОДИОДНЫЕ ТРУБКИ
LED TRUBICE

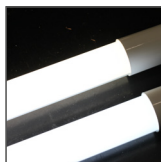

trzonek T8











energooszczędne diody led



plastikowe zabezpieczenie trzpienia

zasilanie jednostronne 230V/50Hz,
oznaczone naklejką

		 [W]	 [lm]		 [K]		 X
kod	EAN	moc [W]	strumień światła [lm]	opakowanie zbiorcze	barwa światła [K]	materiał	długość [cm]
D89-T8-LED060-ZJM-4K	5900280904935	10	860	1/20	4000	szkło	60
D89-T8-LED060-ZJM-6K	5900280914071	10	900	1/20	6000	szkło	60
D89-T8-LED120-ZJM-4K	5900280904942	18	1700	1/20	4000	szkło	120
D89-T8-LED120-ZJM-6K	5900280914095	18	1750	1/20	6000	szkło	120
D89-T8-LED150-ZJM-4K	5900280913319	22	1950	1/20	4000	szkło	150
D89-T8-LED150-ZJM-6K	5900280914118	22	2000	1/20	6000	szkło	150

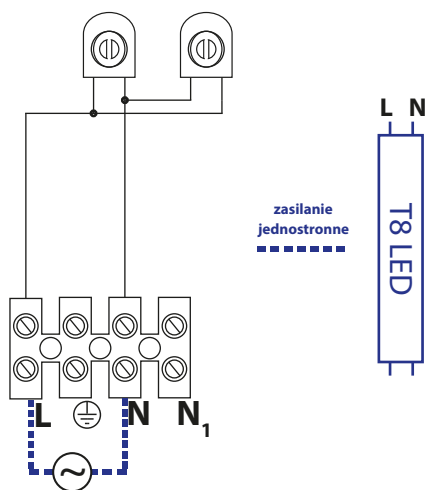

ZJ – zasilanie jednostronne,
ZD – zasilanie dwustronne,
M – klosz mleczny,
P – klosz przezroczysty,

A++
A+

EAC CE



G13
T8

230V~



30000
h